

Julabo
THE TEMPERATURE CONTROL COMPANY

RECIRCULATING COOLERS / CHILLERS



ENGLISH

Product Characteristics & Functions

Display



Easy to read

Large LED temperature display for actual value and setpoint (display resolution 0.1 °C)



A perfect view

Ample, easy to read VFD Comfort display for simultaneous display of 3 values, warning functions, high temperature cut-off, pump stages (display resolution 0.01 °C)



Filling level

Filling volume display



Clear

Comfortable, splash-proof control panel

Temperature Control



Precise

PID Temperature control with set control parameters, temperature stability $\pm 0.02 \dots \pm 0.2$ °C



For higher demands

PID Temperature control with drift compensation and adjustable parameters, improved temperature stability for external applications, temperature stability ± 0.01 °C internal, $< \pm 0.1$ °C external



For perfect results

'Intelligent Cascade Control', automatic & self-optimizing adjustment of PID control parameters, temperature stability ± 0.005 °C internal, $< \pm 0.05$ °C external



Full control

'Temperature Control Features' for individual optimization, access to all important control parameters, additional settings for band limit, limits, co-speed factor, etc.



Direct control from external application

External Pt100 sensor connection for highly precise measurement and control directly in the external application



Highest measuring accuracy

'Absolute Temperature Calibration' for compensation of a temperature difference, 3-point calibration

Refrigeration Technology



Consistent cooling capacity

Easily removable venting grid for quick and easy dust removal



100 % cooling capacity

'Active Cooling Control' for full utilization of the cooling capacity available throughout the entire working temperature range, fast cool-down even at higher temperatures

Technical Features



Clever pump system

Reliable and consistent pump capacity, electronically adjustable pump stages



Serial connection

RS232 interface for PC connection, e.g. for data communication and recording of measured values



Easy program control

Integrated programmer for the execution of time and temperature dependent profiles, 1 temperature profile with 10 steps max., with real time clock



Connection of additional equipment

Stake connections for solenoid valve, HSP booster pump and HST booster heater

Warning & Safety Functions



Early warning system for low liquid level

Maximum safety for applications, optical and audible alarm, allows user to refill bath fluid before the unit shuts down



Early warning system for high/low temperature

Maximum safety for applications, optical and audible alarm convertible to automated cut-off function



Enhanced protective function

Maximum safety, adjustable high temperature cut-off or dry-running protection, additional display of setpoints permits easy and precise adjustments



For flammable bath fluids

Class III (FL) according to DIN 12876-1

The icons can be found on the intro pages of each product group.

Recirculating Coolers / Chillers



AWC100.....6

F Series.....7



FL Series8-13

FC Series.....14-17



SemiChill Series.....18-21

Accessories22-29

Advantages at a Glance.....30-37



Technical Specifications38-41

F /AWC Series



F Series

-10 °C ... +40 °C
3 models with 250, 500, and 1000 W
cooling capacity

The recirculating coolers of the F Series have very low procurement costs and convince with robust technology for continuous operation:

- Up to 1 kW of cooling capacity
- Compact design
- Easy access filling
- Level indicator
- May be used with water, water-glycol



AWC100

+20 °C ... +40 °C
Air-to-water recirculating cooler



Ideal for simple cooling tasks:
The AWC100 requires very little space and has a very low procurement cost.

FL Series



FL Series

-25 °C ... +40 °C
22 models with up to 20 kW of cooling capacity
for laboratory and industrial applications

The recirculating coolers of the FL Series are suited for a wide range of cooling tasks:

- Up to 20 kW of cooling capacity
- Easy access filling from above
- Feed pressure indicator (from FL1201) and level indicator
- Large compensation volume
- Permissible return temperature up to +80 °C
- May be used with water, water-glycol, Thermal bath fluid



The removable venting grid makes it easy to clean the condenser. As a result, the instrument always delivers its full cooling capacity.

FC Series



FC Series

-25 °C ... +80 °C

8 models for heating and cooling tasks with up to 2.5 kW of cooling capacity

FC models offer high temperature stability and are also equipped with integrated heating:

- Up to 2.5 kW of cooling capacity
- 1.2 kW of heating capacity
- Extended working temperatures up to +80 °C
- Adjustable feed/return temperature ratio
- Filling level indicator
- Two LED displays

Models FC1600T and FCW2500T

- External Pt100 sensor connection
- Analog connections for external programming and temperature recorder

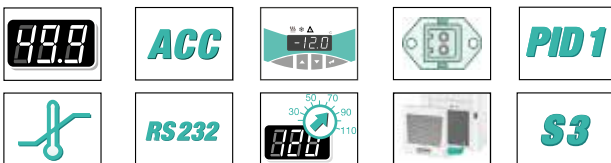

on models FC1600T and FCW2500T



Sophisticated electronics with digital and analog connections for RS232, standby, alarm, external Pt100 sensor, temperature recorder, programming.



SemiChill Series



SemiChill Series

-20 °C ... +130 °C

5 basic models for industrial applications up to 10 kW of cooling capacity, customizable

The SemiChill models are characterized by maximum reliability in continuous operation and under harsh environmental conditions. The modular concept permits custom configurations according to your requirements:

- Five basic models, individually configurable
- Up to 10 kW of cooling capacity
- Up to 12 kW of heating capacity
- Seal-free immersion pumps, maintenance-free and electronically adjustable
- Feed pressure indicator and level indicator
- Overload protection for pump motor and refrigeration unit

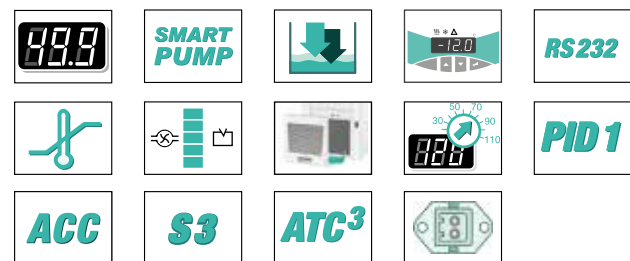

on models with professional electronics



Available with optional DI-filter or micro-filter housing.

Air-to-Water Recirculating Cooler AWC100

for working near ambient temperature

The AWC100 model requires very little space and has a very low procurement cost.

- Plug it in, switch it on, and you're ready to go
- Whisper quiet
- Saves energy (compressor-free design)
- Water loop cooled by fan air
- Uniform pump capacity
- Cooling performance adjustable in two steps
- Filling level indicator

Ambient temperature: +20 °C

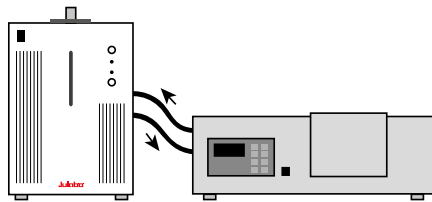

AWC100 is designed to cool water in closed loops. The unit permanently removes heat from water as it flows through the machine.

Applications

Cooling of Peltier elements, particularly for automated analysis units and CCD cameras, polarimeters, refractometers, electrophoresis chambers, condensers for glass apparatus

Example for determining cooling capacity

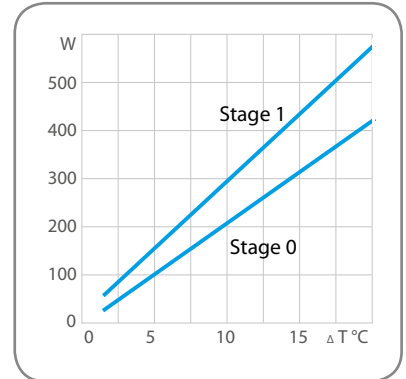

Ambient temperature: +20 °C
Return temperature: +30 °C
ΔT: +10 °C
Cooling capacity (stage 1): 300 W



AWC100

Order No.	9 630 100		
Model	AWC100		
Working temperature range °C ¹⁾	+20 ... +40		
Temperature stability °C	-		
Cooling capacity ¹⁾ W	+20 °C	+10 °C	+5 °C
Stage 0	400	220	120
Stage 1	550	300	180
Pump capacity	l/min	3.5	
Flow rate / Pressure	psi	7.1	
Filling volume liters	0.9		
Dimensions inch	W × L × H 7.9 × 13.4 × 11.8		

1) Cooling capacity depends on the temperature differential between the return flow and ambient environment. Included in delivery: 2 barbed fittings each for tubing 8 and 10 mm ID (pump connections M10x1 female)

Compact Recirculating Coolers

for simple cooling tasks

JULABO F models require very little space and have very low procurement costs.

Recirculating coolers of the F Series are a great way to replace costly tap water and are ideal for basic cooling tasks.

- Environmentally-friendly operation with low energy consumption
- Compact design
- Splash-proof membrane keypad with LED temperature display
- Straightforward filling and draining
- Filling level indicator
- May be used with water, water-glycol

For cooling of

- Rotary evaporators
- Kjeldahl instruments
- Measuring cells
- Automated analysis systems
- CCD cameras
- Polarimeters, refractometers
- Condensers for glass apparatus
- Calorimeters
- Soxhlet apparatuses

Included in delivery with F250: 2 barbed fittings each for tubing 8 and 10 mm ID (pump connections M10x1 female)

Included in delivery with F500, F1000: 2 barbed fittings each for tubing 8 and 12 mm ID (pump connections M16x1 male)



F250		F500			F1000			
Order No.	9 620 025	Order No.	9 620 050		Order No.	9 620 100		
Model	F250	Model	F500		Model	F1000		
Working temperature range °C	-10 ... +40	Working temperature range °C	0 ... +40		Working temperature range °C	0 ... +40		
Temperature stability °C	±0.5	Temperature stability °C	±0.5		Temperature stability °C	±0.5		
Cooling capacity kW	+20 °C 0.25	+10 °C 0.22	+5 °C 0.21	Cooling capacity kW	+20 °C 0.5	+10 °C 0.4	+5 °C 0.3	
	0 °C 0.18	-5 °C 0.09	-10 °C -		0 °C 0.25	-5 °C -	-10 °C -	
Pump capacity	l/min	15	Pump capacity	l/min	24	Pump capacity	l/min	23
Flow rate / Pressure	psi	5.1	Flow rate / Pressure	psi	7.3	Flow rate / Pressure	psi	14.5
Filling volume liters	1.7 ... 2.6		Filling volume liters	5 ... 7.5		Filling volume liters	7 ... 9.5	
Dimensions inch	W × L × H 9.4 × 15.7 × 20.5		Dimensions inch	W × L × H 14.8 × 17.3 × 23.2		Dimensions inch	W × L × H 14.8 × 19.3 × 25.2	

FL Series

FL Recirculating Coolers

compact models with up to 1.7 kW of cooling capacity for installation below a lab bench

The compact FL models are suited for a wide variety of cooling tasks. Installation under a lab bench saves valuable space. 2 variants: Air-cooled (FL) and water-cooled (FLW).

- Easy filling from above
- Feed pressure indicator (FL1201 and above) and level indicator (all models)
- Large compensation volume
- Circulating pumps designed for continuous operation
- Permissible return temperature up to +80 °C
- Low liquid level protection with visual and acoustic signals
- May be used with water, water-glycol, Thermal bath fluid
- Overload protection for pump motor and cooling machine

Pump capacity

Bath fluid: water

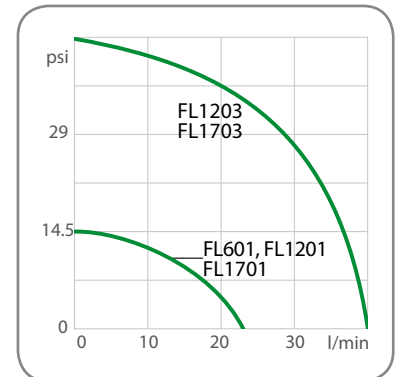

Included in delivery: 2 barbed fittings each for tubing 8 and 12 mm ID (pump connections M16x1 male)
2 barbed fittings for tubing 3/4" ID with models FL1203 and FL(W)1703 (pump connections G 3/4" male)



FL300

Order No.	9 660 003		
Model	FL300		
Working temperature range °C	-20 ... +40		
Temperature stability °C	±0.5		
Cooling capacity kW	+20 °C	+10 °C	0 °C
	0.3	0.25	0.2
Cooling capacity kW	-5 °C	-10 °C	-20 °C
	-	0.15	0.1
Pump capacity	l/min	15	
Flow rate / Pressure	psi	5.1	
Filling volume liters	3 ... 4.5		
Dimensions inch	W × L × H 9.8 × 19.7 × 23.6		



FL601

Order No.	9 661 006		
Model	FL601		
Working temperature range °C	-20 ... +40		
Temperature stability °C	±0.5		
Cooling capacity kW	+20 °C	+10 °C	0 °C
	0.6	0.5	0.4
Cooling capacity kW	-5 °C	-10 °C	-20 °C
	-	0.33	0.2
Pump capacity	l/min	23	
Flow rate / Pressure	psi	14.5	
Filling volume liters	5.5 ... 8		
Dimensions inch	W × L × H 12.6 × 19.7 × 24.4		



FL1201

Order No.	9 661 012		
Model	FL1201		
Working temperature range °C	-20 ... +40		
Temperature stability °C	±0.5		
Cooling capacity kW	+20 °C	+10 °C	0 °C
	1.2	1	0.9
Cooling capacity kW	-5 °C	-10 °C	-20 °C
	-	0.6	0.3
Pump capacity	l/min	23	
Flow rate / Pressure	psi	14.5	
Filling volume liters	12 ... 17		
Dimensions inch	W × L × H 19.7 × 29.9 × 25.2		



FLW1701

Order No.	9 671 017		
Model	FLW1701		
Working temperature range °C	-20 ... +40		
Temperature stability °C	±0.5		
Cooling capacity kW	+20 °C	+10 °C	0 °C
	1.7	1.5	1.1
	-5 °C	-10 °C	-20 °C
	-	0.85	0.4
Pump capacity	l/min	23	
Flow rate / Pressure	psi	14.5	
Filling volume liters	12 ... 17		
Dimensions inch	W × L × H 19.7 × 29.9 × 25.2		



FLW1703

Order No.	9 673 017		
Model	FLW1703		
Working temperature range °C	-20 ... +40		
Temperature stability °C	±0.5		
Cooling capacity kW	+20 °C	+10 °C	0 °C
	1.7	1.4	1
	-5 °C	-10 °C	-20 °C
	-	0.75	0.3
Pump capacity	l/min	40	
Flow rate / Pressure	psi	7.3 ... 43.5	
Filling volume liters	12 ... 17		
Dimensions inch	W × L × H 19.7 × 29.9 × 25.2		



FL1203

Order No.	9 663 012		
Model	FL1203		
Working temperature range °C	-20 ... +40		
Temperature stability °C	±0.5		
Cooling capacity kW	+20 °C	+10 °C	0 °C
	1.2	0.9	0.8
	-5 °C	-10 °C	-20 °C
	-	0.5	0.2
Pump capacity	l/min	40	
Flow rate / Pressure	psi	7.3 ... 43.5	
Filling volume liters	12 ... 17		
Dimensions inch	W × L × H 19.7 × 29.9 × 25.2		



FL1701

Order No.	9 661 017		
Model	FL1701		
Working temperature range °C	-20 ... +40		
Temperature stability °C	±0.5		
Cooling capacity kW	+20 °C	+10 °C	0 °C
	1.7	1.5	1.1
	-5 °C	-10 °C	-20 °C
	-	0.85	0.4
Pump capacity	l/min	23	
Flow rate / Pressure	psi	14.5	
Filling volume liters	12 ... 17		
Dimensions inch	W × L × H 19.7 × 29.9 × 25.2		



FL1703

Order No.	9 663 017		
Model	FL1703		
Working temperature range °C	-20 ... +40		
Temperature stability °C	±0.5		
Cooling capacity kW	+20 °C	+10 °C	0 °C
	1.7	1.4	1
	-5 °C	-10 °C	-20 °C
	-	0.75	0.3
Pump capacity	l/min	40	
Flow rate / Pressure	psi	7.3 ... 43.5	
Filling volume liters	12 ... 17		
Dimensions inch	W × L × H 19.7 × 29.9 × 25.2		

FL Series

FL Recirculating Coolers

powerful models with up to 4.3 kW of cooling capacity, tower version

The FL models shown here have higher cooling capacity, powerful circulating pumps, and internal bath volumes of up to 30 liters. 2 variants: Air-cooled (FL) and water-cooled (FLW).

- Powerful circulating pumps up to 60 l/min; 87 psi
- By-pass valve to adjust pump pressure
- Rollers make it easy to move the units
- Early warning function when condenser is dirty
- Overload protection for pump motor and cooling machine
- Stainless steel bath tank
- BlackBox function with error memory for remote diagnosis
- Stakei connection for connecting a solenoid valve

Applications

Rotary evaporators, bio-reactors/fermenters, Soxhlet apparatuses, distillation systems, vacuum systems, gas chromatographs, spectrometers, semiconductor applications, metering and adhesive technology, diffusion pumps, mass spectrometers, electron microscopes

Filling level indicator

for all models

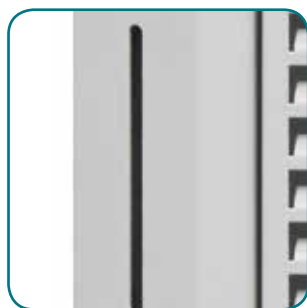

Practical recessed grip



Pump capacity

Bath fluid: water

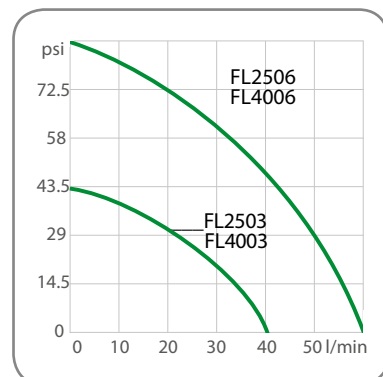

Included in delivery: 2 barbed fittings for tubing 3/4" ID with models FL/FLW2503 and FL/FLW4003 (pump connections G 3/4" male). 2 barbed fittings for tubing 1" ID with models FL/FLW2506 and FL/FLW4006 (pump connections G 1 1/4" male)



FLW2503

Order No.	9 673 025	
Model	FLW2503	
Working temperature range °C	-20 ... +40	
Temperature stability °C	±0.5	
Cooling capacity kW	+20 °C	+10 °C
	2.7	2.5
	0 °C	1.7
Cooling capacity kW	-5 °C	-10 °C
	-	1
	-	0.4
Pump capacity	l/min	40
Flow rate / Pressure	psi	7.3 ... 43.5
Filling volume liters	24 ... 30	
Dimensions inch	W × L × H 23.6 × 29.9 × 45.3	



FL2503

Order No.	9 663 025	
Model	FL2503	
Working temperature range °C	-20 ... +40	
Temperature stability °C	±0.5	
Cooling capacity kW	+20 °C	+10 °C
	2.5	2.2
	0 °C	1.5
Cooling capacity kW	-5 °C	-10 °C
	-	1.2
	-	0.55
Pump capacity	l/min	40
Flow rate / Pressure	psi	7.3 ... 43.5
Filling volume liters	24 ... 30	
Dimensions inch	W × L × H 23.6 × 29.9 × 45.3	



FLW2506

Order No.	9 676 025		
Model	FLW2506		
Working temperature range °C	-15 ... +40		
Temperature stability °C	±0.5		
Cooling capacity kW	+20 °C	+10 °C	0 °C
	2.5	1.9	1
	-5 °C	-10 °C	-20 °C
	-	0.3	-
Pump capacity	l/min	60	
Flow rate / Pressure	psi	7.3 ... 87	
Filling volume liters	24 ... 30		
Dimensions inch	W × L × H 23.6 × 29.9 × 45.3		



FLW4003

Order No.	9 673 040		
Model	FLW4003		
Working temperature range °C	-20 ... +40		
Temperature stability °C	±0.5		
Cooling capacity kW	+20 °C	+10 °C	0 °C
	4.3	3	2.2
	-5 °C	-10 °C	-20 °C
	-	1.3	0.45
Pump capacity	l/min	40	
Flow rate / Pressure	psi	7.3 ... 43.5	
Filling volume liters	24 ... 30		
Dimensions inch	W × L × H 23.6 × 29.9 × 45.3		



FLW4006

Order No.	9 676 040		
Model	FLW4006		
Working temperature range °C	-15 ... +40		
Temperature stability °C	±0.5		
Cooling capacity kW	+20 °C	+10 °C	0 °C
	4	3	1.7
	-5 °C	-10 °C	-20 °C
	-	0.7	-
Pump capacity	l/min	60	
Flow rate / Pressure	psi	7.3 ... 87	
Filling volume liters	24 ... 30		
Dimensions inch	W × L × H 23.6 × 29.9 × 45.3		



FL2506

Order No.	9 666 025		
Model	FL2506		
Working temperature range °C	-15 ... +40		
Temperature stability °C	±0.5		
Cooling capacity kW	+20 °C	+10 °C	0 °C
	2.5	1.9	1
	-5 °C	-10 °C	-20 °C
	-	0.3	-
Pump capacity	l/min	60	
Flow rate / Pressure	psi	7.3 ... 87	
Filling volume liters	24 ... 30		
Dimensions inch	W × L × H 23.6 × 29.9 × 45.3		



FL4003

Order No.	9 663 040		
Model	FL4003		
Working temperature range °C	-20 ... +40		
Temperature stability °C	±0.5		
Cooling capacity kW	+20 °C	+10 °C	0 °C
	4	3.4	2.4
	-5 °C	-10 °C	-20 °C
	-	1.5	0.65
Pump capacity	l/min	40	
Flow rate / Pressure	psi	7.3 ... 43.5	
Filling volume liters	24 ... 30		
Dimensions inch	W × L × H 23.6 × 29.9 × 45.3		



FL4006

Order No.	9 666 040		
Model	FL4006		
Working temperature range °C	-20 ... +40		
Temperature stability °C	±0.5		
Cooling capacity kW	+20 °C	+10 °C	0 °C
	4	2.9	1.9
	-5 °C	-10 °C	-20 °C
	-	0.9	0.05
Pump capacity	l/min	60	
Flow rate / Pressure	psi	7.3 ... 87	
Filling volume liters	24 ... 30		
Dimensions inch	W × L × H 23.6 × 29.9 × 45.3		

FL Series

FL Recirculating Coolers

very powerful units, up to 20 kW of cooling capacity

The powerful FL models are suitable for a wide range of cooling tasks in industrial environments, such as removal of large process heat. 2 variants: Air-cooled (FL) and water-cooled (FLW).

- High cooling capacity of up to 20 kW
- Powerful circulating pumps
- Large power reserves with all applications
- Early warning function when condenser is dirty
- Low water consumption (on FLW models)
- Overload protection for pump motor and cooling machine
- Stainless steel bath tank
- BlackBox function with error memory for remote diagnosis
- Stakei connection for connecting a solenoid valve or a booster pump

Included in delivery: 2 Barbed fittings for tubing 1" ID
(pump connections G 1/4" male)

Pump capacity

Bath fluid: water

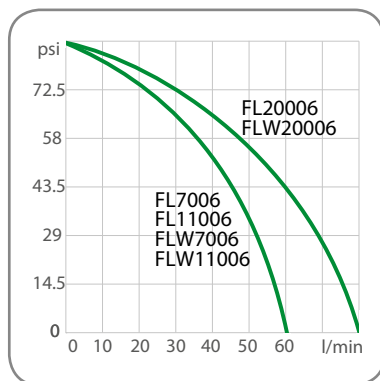

Rollers
add flexibility



Drain tap located behind
removable venting grid



Pump pressure indicator for
models from FL1201



Pump pressure adjustable
for models from 43.5 psi



FLW7006

Order No. 9 676 070

Model FLW7006

Working temperature range °C -20 ... +40

Temperature stability °C ±0.5

Cooling capacity kW	+20 °C	+10 °C	0 °C
	7.4	7	5.5
	-5 °C	-10 °C	-20 °C
	-	3.1	1.3

Pump capacity l/min 60
Flow rate / Pressure psi 7.3 ... 87

Filling volume liters 39 ... 47

Dimensions inch W × L × H
30.7 × 33.5 × 58.3



FLW11006

Order No. 9 676 110

Model FLW11006

Working temperature range °C -20 ... +40

Temperature stability °C ±0.5

Cooling capacity kW	+20 °C	+10 °C	0 °C
	11.5	9	7.3
	-5 °C	-10 °C	-20 °C
	-	4.8	2.7

Pump capacity l/min 60
Flow rate / Pressure psi 7.3 ... 87

Filling volume liters 39 ... 47

Dimensions inch W × L × H
30.7 × 33.5 × 58.3



FLW20006

Order No. 9 676 200

Model FLW20006

Working temperature range °C -25 ... +40

Temperature stability °C ±0.5

Cooling capacity kW	+20 °C	+10 °C	0 °C
	20	15	12
	-5 °C	-10 °C	-20 °C
	-	7	3

Pump capacity l/min 80
Flow rate / Pressure psi 11.6 ... 87

Filling volume liters 15 ... 37

Dimensions inch W × L × H
37.4 × 45.3 × 63.4



FL7006

Order No. 9 666 070

Model FL7006

Working temperature range °C -20 ... +40

Temperature stability °C ±0.5

Cooling capacity kW	+20 °C	+10 °C	0 °C
	7	6.4	5.1
	-5 °C	-10 °C	-20 °C
	-	3	1.55

Pump capacity l/min 60
Flow rate / Pressure psi 7.3 ... 87

Filling volume liters 39 ... 47

Dimensions inch W × L × H
30.7 × 33.5 × 58.3



FL11006

Order No. 9 666 110

Model FL11006

Working temperature range °C -20 ... +40

Temperature stability °C ±0.5

Cooling capacity kW	+20 °C	+10 °C	0 °C
	11	9	7.5
	-5 °C	-10 °C	-20 °C
	-	5	3

Pump capacity l/min 60
Flow rate / Pressure psi 7.3 ... 87

Filling volume liters 39 ... 47

Dimensions inch W × L × H
30.7 × 33.5 × 58.3



FL20006

Order No. 9 666 200

Model FL20006

Working temperature range °C -25 ... +40

Temperature stability °C ±0.5

Cooling capacity kW	+20 °C	+10 °C	0 °C
	20	15	10
	-5 °C	-10 °C	-20 °C
	-	6	2.5

Pump capacity l/min 80
Flow rate / Pressure psi 11.6 ... 87

Filling volume liters 15 ... 37

Dimensions inch W × L × H
37.4 × 45.3 × 63.4

FC Series

FC Recirculating Coolers

for heating and cooling tasks

FC models offer high temperature stability and feature integrated heating in addition.

2 variants: Air-cooled (FC) and water-cooled (FCW).

- Extended working temperatures up to +80 °C
- Two LED displays
- Adjustable feed/return temperature ratio
- Filling level indicator

Pump capacity

Bath fluid: water

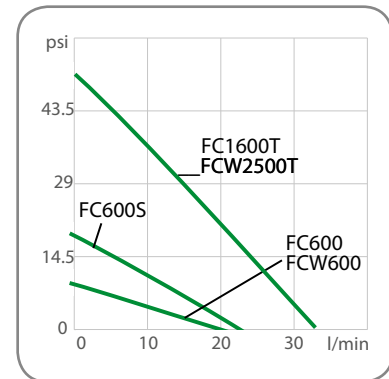

What cooling capacity do you need for your application?

The JULABO temperature control specialists can already calculate an ideal cooling capacity for you based on little data. JULABO merely needs three values, which you can determine easily for your application in most cases:

- | 1
Temperature of the cooling water prior to entering the application
- | 2
Temperature of the cooling water after exiting the application
- | 3
Cooling water flow rate in liters per minute

Send these three values to info@julabo.us. You will promptly receive a recommendation regarding the most suitable JULABO recirculating cooler.





FCW600

Order No.	9 601 060		
Model	FCW600		
Working temperature range °C	-20 ... +80		
Temperature stability °C	±0.2		
Heating capacity kW	1.2		
Cooling capacity kW	+20 °C	+10 °C	+5 °C
	0.6	0.47	0.4
	0 °C	-10 °C	-20 °C
	0.34	0.21	-
Pump capacity	l/min	20	
Flow rate / Pressure	psi	7.3	
Filling volume liters	6 ... 8		
Dimensions inch	W × L × H 13.8 × 21.3 × 19.3		



FCW600S

Order No.	9 601 063		
Model	FCW600S		
Working temperature range °C	-10 ... +80		
Temperature stability °C	±0.2		
Heating capacity kW	1.2		
Cooling capacity kW	+20 °C	+10 °C	+5 °C
	0.5	0.37	0.3
	0 °C	-10 °C	-20 °C
	0.24	0.1	-
Pump capacity	l/min	22	
Flow rate / Pressure	psi	17.4	
Filling volume liters	6 ... 8		
Dimensions inch	W × L × H 13.8 × 21.3 × 19.3		



FC600

Order No.	9 600 060		
Model	FC600		
Working temperature range °C	-20 ... +80		
Temperature stability °C	±0.2		
Heating capacity kW	1.2		
Cooling capacity kW	+20 °C	+10 °C	+5 °C
	0.6	0.47	0.4
	0 °C	-10 °C	-20 °C
	0.34	0.21	-
Pump capacity	l/min	20	
Flow rate / Pressure	psi	7.3	
Filling volume liters	6 ... 8		
Dimensions inch	W × L × H 13.8 × 21.3 × 19.3		



FC600S

Order No.	9 600 063		
Model	FC600S		
Working temperature range °C	-10 ... +80		
Temperature stability °C	±0.2		
Heating capacity kW	1.2		
Cooling capacity kW	+20 °C	+10 °C	+5 °C
	0.5	0.37	0.3
	0 °C	-10 °C	-20 °C
	0.24	0.1	-
Pump capacity	l/min	22	
Flow rate / Pressure	psi	17.4	
Filling volume liters	6 ... 8		
Dimensions inch	W × L × H 13.8 × 21.3 × 19.3		

Included in delivery: 2 barbed fittings each for tubing 8 and 12 mm inner dia. (pump connections M16x1 male)

FC Recirculating Coolers

for heating and cooling tasks

FC models offer high temperature stability and feature integrated heating in addition.

2 variants: Air-cooled (FC) and water-cooled (FCW).

Models FC1600T, FCW2500T

External Pt100 sensor connection

Analog connections for external programming and temperature recorder

Pump capacity

Bath fluid: water

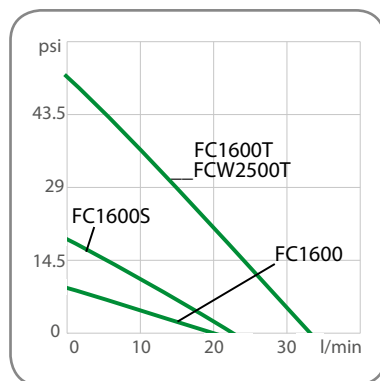

FC1600

Order No.	9 600 160		
Model	FC1600		
Working temperature range °C	-20 ... +80		
Temperature stability °C	±0.2		
Heating capacity kW	1.2		
Cooling capacity kW	+20 °C	+10 °C	+5 °C
	1.65	1.25	1
	0 °C	-10 °C	-20 °C
	0.86	0.47	-
Pump capacity	l/min	20	
Flow rate / Pressure	psi	7.3	
Filling volume liters	8 ... 11		
Dimensions inch	W × L × H 18.1 × 24 × 19.3		

Digital/analog connections

- ① RS232 interface
- ② Standby input
- ③ Alarm output

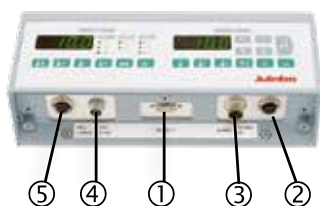

FC1600T and FCW2500T offer in addition:

- ④ External Pt100 sensor
- ⑤ External programming, Temperature recorder

Included in delivery: 2 barbed fittings each for tubing 8 and 12 mm ID (pump connections M16x1 male)



FC1600S

Order No.	9 600 163		
Model	FC1600S		
Working temperature range °C	-15 ... +80		
Temperature stability °C	±0.2		
Heating capacity kW	1.2		
Cooling capacity kW	+20 °C	+10 °C	+5 °C
	1.55	1.15	0.9
	0 °C	-10 °C	-20 °C
	0.76	0.36	-
Pump capacity	l/min	22	
Flow rate / Pressure	psi	17.4	
Filling volume liters	8 ... 11		
Dimensions inch	W × L × H 18.1 × 24 × 19.3		

FC1600T

Order No.	9 600 166		
Model	FC1600T		
Working temperature range °C	-15 ... +80		
Temperature stability °C	±0.2		
Heating capacity kW	1.2		
Cooling capacity kW	+20 °C	+10 °C	+5 °C
	1.45	1.05	0.8
	0 °C	-10 °C	-20 °C
	0.65	0.25	-
Pump capacity	l/min	28	
Flow rate / Pressure	psi	50.8	
Filling volume liters	8 ... 11		
Dimensions inch	W × L × H 18.1 × 24 × 19.3		

FCW2500T

Order No.	9 601 256		
Model	FCW2500T		
Working temperature range °C	-25 ... +80		
Temperature stability °C	±0.2		
Heating capacity kW	1.2		
Cooling capacity kW	+20 °C	+10 °C	+5 °C
	2.5	2	1.8
	0 °C	-10 °C	-20 °C
	1.4	0.8	0.25
Pump capacity	l/min	28	
Flow rate / Pressure	psi	50.8	
Filling volume liters	8 ... 11		
Dimensions inch	W × L × H 18.1 × 24 × 19.3		

SemiChill Recirculating Coolers

for highest requirements in industrial environments

The SemiChill models are characterized by maximum reliability in continuous operation and under harsh environmental conditions. All parts in contact with the bath fluid are made of stainless steel or high grade plastic. The modular design permits custom configurations according to your requirements.

- Five basic models, individually configurable
- High cooling capacity and strong circulating pumps
- Optional with integrated heater with a heating capacity of up to 12 kW
- Seal-free immersion pumps, maintenance-free and electronically adjustable
- Pressure and filling level indicator
- Sealed filling port (70 mm dia.)
- Overload protection for pump motor and cooling machine
- Pump connections: NPT 3/4" male

Models with type designation

- "a" = air cooling
- "w" = water cooling

Applications

Semiconductor industry (etching processes, stainless steel chucks, PVD, sputtering, wet benches), packaging industry, plastics industry, metering and adhesive technology, jacketed reaction vessels, kilo labs, pilot plants



SC2500a

Order No.	Order index on page 21		
Model	SC2500a		
Working temperature range °C ¹⁾	-20 ... +80		
Temperature stability °C	±0.1		
Cooling capacity kW	+20 °C 2.5	0 °C 1.5	-10 °C 0.9
Pump capacity	l/min	Order index on page 21	
Flow rate / Pressure	psi		
Filling volume liters	21 ... 33		
Dimensions inch	W × L × H 19.3 × 24.4 × 41.3		



SC2500w

Order No.	Order index on page 21		
Model	SC2500w		
Working temperature range °C ¹⁾	-20 ... +80		
Temperature stability °C	±0.1		
Cooling capacity kW	+20 °C 2.5	0 °C 1.5	-10 °C 0.9
Pump capacity	l/min	Order index on page 21	
Flow rate / Pressure	psi		
Filling volume liters	21 ... 33		
Dimensions inch	W × L × H 19.3 × 24.4 × 41.3		

¹⁾ Maximum working temperature range (standard working temperature range +5 ... +35 °C)

Pump capacity P3

Bath fluid: water

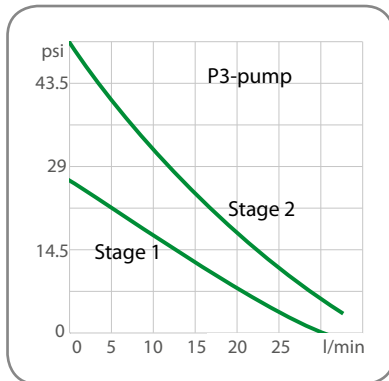

Pump capacity P4

Bath fluid: water

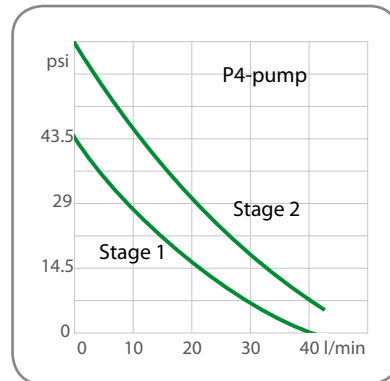

SC5000a

Order No. Order index on page 21

Model SC5000a

Working temperature range °C ¹⁾ -20 ... +130

Temperature stability °C ±0.1

Cooling capacity kW **+20 °C** **0 °C** **-10 °C**
5.0 2.5 1.2

Pump capacity l/min Order index on page 21
Flow rate / Pressure psi

Filling volume liters 43 ... 60

Dimensions inch W × L × H
23.2 × 26.4 × 44.1



SC5000w

Order No. Order index on page 21

Model SC5000w

Working temperature range °C ¹⁾ -20 ... +130

Temperature stability °C ±0.1

Cooling capacity kW **+20 °C** **0 °C** **-10 °C**
5.0 2.5 1.2

Pump capacity l/min Order index on page 21
Flow rate / Pressure psi

Filling volume liters 43 ... 60

Dimensions inch W × L × H
23.2 × 26.4 × 44.1



SC10000w

Order No. Order index on page 21

Model SC10000w

Working temperature range °C ¹⁾ -20 ... +130

Temperature stability °C ±0.1

Cooling capacity kW **+20 °C** **0 °C** **-10 °C**
10.0 5.0 2.5

Pump capacity l/min Order index on page 21
Flow rate / Pressure psi

Filling volume liters 43 ... 60

Dimensions inch W × L × H
23.2 × 26.4 × 44.1

Operating and control electronics

Equipment features



Multi-Display (LED) temperature display	•	
VFD Comfort display with simultaneous display of 3 values		•
Keypad, splash-proof	•	•
PID temperature control	•	•
3-point calibration	•	•
Pump capacity adjustable in stages	•	•
RS232 interface	•	•
Stakei connections for power supply (e.g. shut-off valve)	•	•
Early warning system for low level, high and low temperature limits	•	•
High-temperature cut-off adjustable via display	•	•
Low liquid level protection with cut-off function	•	•
Classification III (DIN 12876-1)	•	•
Remote diagnosis function via integrated <i>BlackBox</i>	•	•
Connector for external Pt100 sensor for measuring and controlling the external system		•
Integrated programmer with real time clock for 1x10 program steps		•
Quantitative conductivity measurement and display, range 0.5...5 Ω/cm		•
Flow measurement and status display (pre-set limit value)*		•
Options for <i>Professional</i> electronics		
Freely scalable analog interfaces (E-PROG input, standby input, alarm output)	--	Optional
RS485 interface	--	Optional

**Professional* electronics with analog connections required. Flow sensor not included.

Further options for working temperature, pump capacity, and heating

Model	Working temperature range				Circulating pumps		Heaters			
	Standard +5 °C ... +35 °C	Low temp -20 °C ... +35 °C	Low/high temp I -20 °C ... +80 °C	Low/high temp II -20 °C ... +130 °C	P3 33 l/min 50.8 psi	P4 43 l/min 62.4 psi	H0 no heater	H1 1 kW	H5 5 kW	H12 12 kW
SC2500a SC2500w	✓	Optional	Optional	--	✓	--	✓	Optional	--	--
SC5000a SC5000w SC10000w	✓	Optional	Optional	Optional	✓	Optional ¹⁾	✓	--	Optional	Optional

✓ This feature is already included with the basic model ¹⁾ Cooling capacity reduced by 0.2 kW

Filter housings

Please specify the desired filter option when ordering. Retrofitting is not possible. Housing is mounted on the right side of the unit.

- D1** DI-filter housing, plastic (up to +35 °C), incl. cartridge
- D2** DI-filter housing, stainless steel (up to +90 °C), incl. cartridge
- M1** Micro-filter housing, plastic (up to +35 °C), w/o cartridge
- M2** Micro-filter housing, stainless steel (up to +130 °C), w/o cartridge

Filter housings for DI-filter and micro-filter (optional)



Order index

for your custom unit configuration

Combine one of the five basic models with options of your choice. Please use the order index shown below to create the order number for your unit. The following example is for model SC5000a:

9	5	2	1	050	07	P3	H0	D0	M1
9	5	x	x	xxx	xx	xx	xx	xx	xx
		a	b	c	d	e	f	g	h

Custom unit configuration

- > Control electronics
- > Pump capacity
- > Working temperature
- > Interfaces
- > Heating capacity
- > Filter housings



9	5	x	x	xxx	xx	xx	xx	xx	xx
---	---	---	---	-----	----	----	----	----	----

Keypad and control electronics

- 0 Eco
- 2 Professional
- 3 Professional with analog interface module
- 7 Professional with RS485 interface

9	5	x	x	xxx	xx	xx	xx	xx	xx
---	---	---	---	-----	----	----	----	----	----

Circulating pump (pump type, pump capacity)

- P3 33 l/min. - 50.8 psi max.
- P4 43 l/min. - 62.4 psi max.

9	5	x	x	xxx	xx	xx	xx	xx	xx
---	---	---	---	-----	----	----	----	----	----

Working temperature range

- 0 Standard (+5 ... +35 °C)
- 1 LowTemp (-20 ... +35 °C)
- 2 Low/HighTemp I (-20 ... +80 °C)
- 3 Low/HighTemp II (-20 ... +130 °C)

9	5	x	x	xxx	xx	xx	xx	xx	xx
---	---	---	---	-----	----	----	----	----	----

Integrated heater

- H0 Without heater
- H1 Heating capacity 1 kW
- H5 Heating capacity 5 kW
- H12 Heating capacity 12 kW

9	5	x	x	xxx	xx	xx	xx	xx	xx
---	---	---	---	-----	----	----	----	----	----

Basic model

- 025 SC2500a
- 026 SC2500w
- 050 SC5000a
- 051 SC5000w
- 101 SC10000w

9	5	x	x	xxx	xx	xx	xx	xx	xx
---	---	---	---	-----	----	----	----	----	----

DI-filter housing

- D0 Without DI-filter housing
- D1 DI-filter housing, plastic (up to +35 °C max.)
- D2 DI-filter housing, stainless steel (up to +90 °C max.)

9	5	x	x	xxx	xx	xx	xx	xx	xx
---	---	---	---	-----	----	----	----	----	----

Voltage version¹⁾

- 03 230 V / 50 Hz
- 07 400 V (3 Ph.) / 50 Hz
- 13 208-230 V / 60 Hz
- 16 208-230 V (3 Ph.) / 60 Hz

9	5	x	x	xxx	xx	xx	xx	xx	xx
---	---	---	---	-----	----	----	----	----	----

Micro-filter housing

- M0 Without micro-filter housing
- M1 Micro-filter housing, plastic (up to +35 °C max.)
- M2 Micro-filter housing, stainless steel (up to +130 °C max.)

¹⁾ Voltage version

SC2500a, SC2500w	SC5000a, SC5000w, SC10000w
230 V / 50 Hz or 208-230 V / 60 Hz	400 V (3 ph.) / 50 Hz or 208-230 V (3 ph.) / 60 Hz

Accessories

JULABO Thermal Bath Fluids

JULABO Thermal bath fluids have been carefully chosen following long term testing. They are highly suitable for all of your temperature control applications guaranteeing safe and reliable operation. Choosing the proper bath fluid is critical for high performance temperature control. The viscosity and heat transfer characteristics of the Thermal fluids are specifically selected for use with JULABO temperature control instruments.

Advantages

- Wide temperature ranges
- Low viscosity
- High stability
- Good heat conductivity
- Minimum odor
- Long shelf life

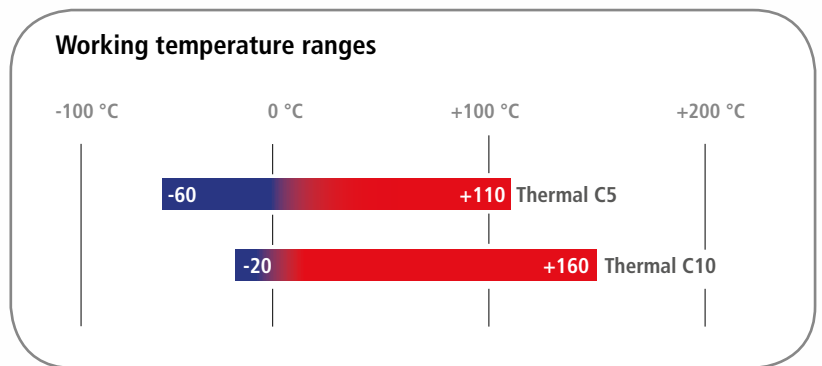

Makes routine laboratory work easier.

JULABO Thermal bath fluids are delivered in containers with a handy drain tap.



Thermal C5

Order No. 5 liters	8 891 403
Order No. 10 liters	8 891 402
Working temperature range °C	-60 ... +110
Flash point °C	+135
Fire point °C	+443
Viscosity, (kinematic at +20 °C) mm ² /s	5
Density (at +20 °C) g/cm ³	0.92
Pour point °C	-100
Boiling point °C	+205
Ignition temperature °C	+443
Color	clear

Thermal C10

Order No. 5 liters	8 891 405
Order No. 10 liters	8 891 404
Working temperature range °C	-20 ... +160
Flash point °C	>+163
Fire point °C	+325
Viscosity, (kinematic at +20 °C) mm ² /s	10
Density (at +20 °C) g/cm ³	0.93
Pour point °C	<-60
Boiling point °C	+205
Ignition temperature °C	+370
Color	clear

JULABO Thermal bath fluids based on silicone ...

... are chemically inert substances which do not affect metals like iron, copper, zinc, aluminum, chrome or nickel. Compared to other fluids, JULABO Thermal fluids have an extraordinarily low electrical conductivity. When properly stored, the fluids will last for 12 months and longer as they are not susceptible to climatic influences.

JULABO Thermal bath fluids based on water-glycol ...

... (monoethyleneglycol with anti-corrosion additives) have excellent thermal characteristics and a low viscosity. In addition, they provide anti-freeze protection, i.e. they can be applied at temperatures below the freezing point of water.

More information on JULABO Thermal bath fluids ...

... in our brochure 'Thermal Bath Fluids' at www.julabo.us.

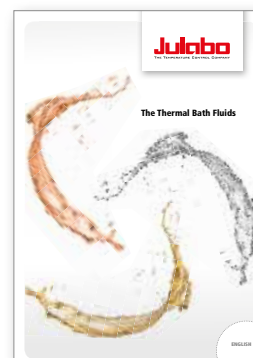

Accessories



CR® tubing (-30 °C ... +120 °C)

Order No.	Description	Suitable for
8 930 008	1 m, 8 mm inner dia.	AWC100, F250, FL300
8 930 010	1 m, 10 mm inner dia.	AWC100, F250
8 930 012	1 m, 12 mm inner dia.	FL300



Reinforced tubing

Order No.	Description	Suitable for
8 930 308	1 m reinforced tubing, 8 mm ID, pressure resistant (-40 °C ... +120 °C)	F500, F1000, FL601/1201/1701, FC models
8 930 312	1 m reinforced tubing, 12 mm / ½" ID, pressure resistant (-40 °C ... +120 °C)	F500, F1000, FL601/1201/1701, FC models
8 930 319	1 m reinforced tubing, ¾" ID, pressure resistant (-40 °C ... +120 °C)	FL(W)1203/1703/2503/4003
8 930 325	1 m reinforced tubing, 1" ID, pressure resistant (-40 °C ... +120 °C)	FL(W)2506/4006/7006/11006/20006



Tubing insulation

Order No.	Description	Suitable for
8 930 410	1 m, for tubing 8 - 10 mm inner dia.	CR® / Viton® tubing
8 930 412	1 m, for tubing 12 mm inner dia.	CR® / Viton® tubing
8 930 413	1 m insulation, 23 mm ID	Reinforced tubing 12 mm / ½" ID
8 930 419	1 m insulation, 29 mm ID	Reinforced tubing ¾" ID
8 930 425	1 m insulation, 35 mm ID	Reinforced tubing 1" ID



Tube clamps

Order No.	Description	Suitable for
8 970 480	2 Tube clamps, size 1	CR® tubing, 8 mm ID
8 970 481	2 Tube clamps, size 2	CR® tubing 10/12 mm ID, Reinforced tubing 8 mm ID
8 970 482	2 Tube clamps, size 3	Reinforced tubing 12 mm / ½" ID
8 970 483	2 Tube clamps, size 4	Reinforced tubing ¾" ID
8 970 484	2 Tube clamps, size 5	Reinforced tubing 1" ID



Twin and quad distributing adapters with barbed fittings

Order No.	Description	Suitable for
8 970 470	Twin distributing adapter with barbed fittings for tubing 8 mm ID	F, FL, FC
8 970 472	Twin distributing adapter with barbed fittings for tubing 10 mm ID	F, FL, FC
8 970 471	Twin distributing adapter with barbed fittings for tubing 12 mm ID	F, FL, FC
8 970 476	Twin distributing adapter G ¾" with barbed fittings for tubing ¾" ID	FL(W)1203/1703/2503/4003
8 970 477	Twin distributing adapter G 1¼" with barbed fittings for tubing 1" ID	FL(W)2506/4006/7006/11006/20006
8 970 474	Quad distributing adapter (2 pieces), M16x1, with barbed fittings for tubing 8 mm or 12 mm / ½" ID	FC
8 970 520	Quad distributing adapter (2 pieces), M16x1, with barbed fittings for tubing 8 mm or 12 mm / ½" ID	F500, F1000, FL(W)601/1201/1701

Order No.	Description	Suitable for
8 970 522	Quad distributing adapter (2 pieces), G 3/4" female, with barbed fittings for tubing 3/4" ID	FL(W)1203/1703/2503/4003
8 970 524	Quad distributing adapter (2 pieces), G 1 1/4" female, with barbed fittings for tubing 1" ID	FL(W)2506/4006/7006/11006/20006

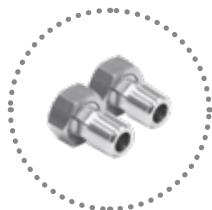

Adapters and connectors

Order No.	Description	Suitable for
8 890 036	2 Barbed fittings for tubing 1/2" ID to NPT 3/4" female	SemiChill
8 890 037	2 Barbed fittings for tubing 5/8" ID to NPT 3/4" female	SemiChill
8 890 038	2 Adapters NPT 3/4" female to M16x1 male	SemiChill
8 890 040	2 Adapters G 3/4" female to M16x1 male	FL(W)1203/1703/2503/4003
8 890 041	2 Adapters G 1 1/4" female to M16x1 male	FL(W)2506/4006/7006/11006/20006
8 890 042	2 Adapters G 3/4" female to barbed fitting for tubing 1/2" ID	FL(W)1203/1703/2503/4003
8 890 043	2 Adapters G 3/4" female to barbed fitting for tubing 3/4" ID	FL(W)1203/1703/2503/4003
8 890 044	2 Adapters G 1 1/4" female to barbed fitting for tubing 1/2" ID	FL(W)2506/4006/7006/11006/20006
8 890 045	2 Adapters G 1 1/4" female to barbed fitting for tubing 3/4" ID	FL(W)2506/4006/7006/11006/20006
8 890 046	2 Adapters G 1 1/4" female to barbed fitting for tubing 1" ID	FL(W)2506/4006/7006/11006/20006
8 890 047	2 Adapters G 3/4" female to NPT 1/2" male	FL(W)1203/1703/2503/4003
8 890 048	2 Adapters G 3/4" female to NPT 3/4" male	FL(W)1203/1703/2503/4003
8 890 049	2 Adapters G 1 1/4" female to NPT 1/2" male	FL(W)2506/4006/7006/11006/20006
8 890 050	2 Adapters G 1 1/4" female to NPT 3/4" male	FL(W)2506/4006/7006/11006/20006
8 890 051	2 Adapters G 1 1/4" female to NPT 1" male	FL(W)2506/4006/7006/11006/20006

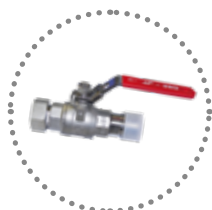

Particle filters / Shut-off valves / Solenoid valve / Castor platform

Order No.	Description	Suitable for
8 970 905	Air filter	AWC100
8 970 906	Filter cartridge	AWC100
8 920 000	Particle filter for cooling water circuit (for water-cooled models)	FLW, FCW, SC5000w, SC10000w, SC2500W
8 970 456	Shut-off valve for loop circuit M16x1	F500, F1000, FL300/601/1201/1701, FC, FCW
8 970 454	Shut-off valve G 3/4"	FL(W)1203/1703/2503/4003
8 970 458	Shut-off valve G 1 1/4"	FL(W)2506/4006/7006/11006/20006
8 980 701	Solenoid valve set for loop circuit (max. +100 °C), M16x1	FC, FCW
8 910 045	Castor platform	F250
8 920 016	Micro-filter cartridge 10 micron	SemiChill with option M1
8 920 017	Micro-filter cartridge 25 micron	SemiChill with option M1
8 920 018	Micro-filter cartridge 40 micron	SemiChill with option M1
8 920 019	Micro-filter cartridge 100 micron	SemiChill with option M1
8 920 020	Micro-filter cartridge 250 micron	SemiChill with option M1
8 920 036	Micro-filter cartridge 10 micron	SemiChill with option M2
8 920 038	Micro-filter cartridge 40 micron	SemiChill with option M2
8 920 039	Micro-filter cartridge 100 micron	SemiChill with option M2
8 920 040	Micro-filter cartridge 250 micron	SemiChill with option M2
8 920 005	DI filter cartridge	DI-filter housing, plastic/stainless steel D1/D2
8 920 100	Drain tap, stainless steel, to empty bath easily	SemiChill
8 980 705	Solenoid valve set, 230 V/50-60 Hz, -10 ... +130 °C (Included in delivery: 1 solenoid valve and 1 back pressure valve)	SemiChill

Accessories



External Pt100 sensors and extension cables

Order No.	Description	Suitable for
8 981 003	200 × 6 mm dia., stainless steel, 1.5 m cable	FC-T variant, SemiChill with professional electronics
8 981 006	20 × 2 mm dia., stainless steel, 1.5 m cable	FC-T variant, SemiChill with professional electronics
8 981 010	300 × 6 mm dia., stainless steel, 1.5 m cable	FC-T variant, SemiChill with professional electronics
8 981 017	200 × 6 mm dia., stainless steel/PTFE coated, 3 m cable	FC-T variant, SemiChill with professional electronics
8 981 015	300 × 6 mm dia., stainless steel/PTFE coated, 3 m cable	FC-T variant, SemiChill with professional electronics
8 981 013	600 × 6 mm dia., stainless steel/PTFE coated, 3 m cable	FC-T variant, SemiChill with professional electronics
8 981 016	900 × 6 mm dia., stainless steel/PTFE coated, 3 m cable	FC-T variant, SemiChill with professional electronics
8 981 014	1200 × 6 mm dia., stainless steel/PTFE coated, 3 m cable	FC-T variant, SemiChill with professional electronics
8 981 020	M+R in-line Pt100 sensor, 2 connections M16x1 male	FC-T variant, SemiChill with professional electronics
8 981 103	Extension cable 3.5 m for Pt100 sensor	FC-T variant, SemiChill with professional electronics



Connection plugs and converters

Order No.	Description	Suitable for
8 980 131	External Pt100 sensor connector	FC-T variant, SemiChill with professional electronics
8 980 133	Standby connector, 3 pin	FC, SemiChill with professional electronics
8 980 135	Alarm connector, 5 pin	FL, FC, SemiChill with professional electronics
8 980 136	REG+EPROG connector, 6 pin	FC-T variant, SemiChill with professional electronics
8 980 137	Stakei connector	FC, SemiChill, from FL 2503
8 980 024	SCB converter box	FC, SemiChill



Software and hardware for instrument control, data recording and visualization, interfaces

Order No.	Description	Suitable for
8 900 020	Profibus DP interface	FL, FC, SemiChill
8 900 024	RS485 interface	FL, FC, SemiChill
8 900 110	USB interface adapter cable, 2.5 m	FL, FC, SemiChill
8 901 102	EasyTEMP Software (free of charge at www.julabo.us)	FL, FC, SemiChill
8 901 105	EasyTEMP Professional Software, incl. USB Dongle	FL, FC, SemiChill
8 980 031	Ethernet / RS232 interface converter for temperature control instruments with RS232 interface.	FL, FC, SemiChill
8 980 032	Ethernet / RS232 Converter Connection of up to 4 JULABO instruments via RS232 interface cable (8980074). Connection to an existing network via RJ45 cable (8980071).	FL, FC, SemiChill
8 980 033	Ethernet / RS232 Converter Connection of up to 8 JULABO instruments via RS232 interface cable (8980074). Connection to an existing network via RJ45 cable (8980071).	FL, FC, SemiChill

Order No.	Description	Suitable for
8 980 034	WLAN/RS232 converter	FL, FC, SemiChill
8 980 035	2 Channel WLAN/RS232 converter	FL, FC, SemiChill
8 980 036	ATEX Tablet Agile X	FL, FC, SemiChill
8 980 073	RS232 interface cable, length 2,5 m. Interface cable RS232 9-pole/9-pole	FL, FC, SemiChill
8 980 074	RS232 interface cable, length 5 m. Interface cable RS232 9-pole/9-pole.	FL, FC, SemiChill



Calibration and testing certificates

Order No.	Description	Suitable for
8 902 901	1-Point Manufacturer's calibration certificate	All models except AWC100
8 902 903	3-Point Manufacturer's calibration certificate	All models except AWC100
8 902 905	5-Point Manufacturer's calibration certificate	All models except AWC100
8 903 025	Manufacturer's testing certificate for JULABO units (with up to 1 kW cooling capacity at +20 °C)	All models except AWC100
8 903 035	Manufacturer's testing certificate for JULABO units (starting from 1 kW cooling capacity at +20 °C)	All models except AWC100



IQ/OQ Documentation for equipment qualification

Order No.	Description	Suitable for
2 310 120	IQ/OQ Documentation, Category 2	F, FL, FC
2 310 130	IQ/OQ Documentation, Category 3	SemiChill



Preventative maintenance contracts

Order No.	Description	Suitable for
2 350 100	Preventative maintenance contract standard includes the following services: Visual inspection, technical diagnostics, read-out of error memory (BlackBox), testing of tube connections and bath fluid, thorough cleaning of performance-reducing contaminations, testing of control behavior (temperature stability), sensor calibration as needed, testing/measuring of pump and cooling capacity (depending on model) and firmware update (if no hardware adjustment is required)	All models
2 350 110	Preventative maintenance contract premium includes all services listed above as well as spare and wear parts and labor required for installation and replacement	All models

Booster Pump

The new JULABO magnetically coupled Booster Pump is the ideal solution to increase the pressure or flow rate in your application. The Booster Pump is specifically designed to be easily connected between various JULABO instruments and your application.

The Booster Pump can add 30.5 psi to your fluid pressure. The stainless steel design of the pump provides excellent resistivity against chemical effects. The pump design guarantees 100 % leakage free operation over an extraordinary temperature range of -90 °C ... +250 °C.

The Booster Pump is suitable for FC and SemiChill recirculating coolers*³⁾

Pump connector cable for connection of the SBC converter box is included in the delivery.

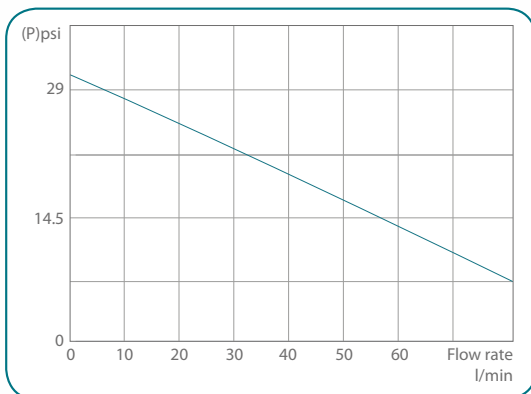

(Measured in a fluid with a density of 1 kg/dm³)



Booster Pump (Magnetically Coupled)

Order No.	8 810 020	
Model	Booster Pump	
Working temperature range °C	-90 ... 250	
Pump type	Centrifugal pump	
Material Pump / housing	Stainless steel	
Pump capacity	l/min	80
Flow rate / Pressure	psi	30.5 ^{*1)}
Pump pressure adjustment	Manual	
Pump pressure display	2 manometers, for input and output pressure	
Suitable fluids	Water-glycol, silicon oil, Fluorinert®	
Viscosity max. cSt.	50	
Fluid connectors	M30x1.5 male ^{*2)}	
Mains power supply	208 – 230V ±10 % / 50-60 Hz 1~	
Power consumption	1.85 A (208 V) / 2 A (230 V)	
Heat input W	230 at full motor speed	
Control input	3-pin connector for SCB converter box	
Weight lbs	29.1	
Dimensions inch	W × L × H 71 × 108 × 61	

*¹⁾ In addition to the pump pressure of the suitable JULABO instrument.

*²⁾ Adapters may be required.

*³⁾ The JULABO SCB converter box (Order No. 8 980 024) is required.

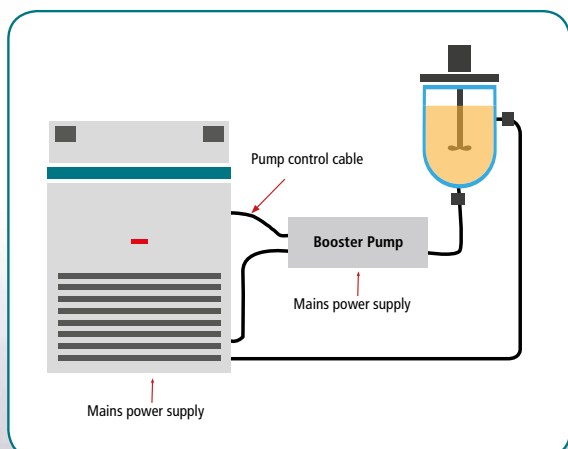

Plate Heat Exchanger

Plate heat exchangers from JULABO are the ideal solution for applications, in which the bath fluid cannot be used directly in the temperature control instrument.

Depending on the application, this may be the case for example due to viscosity, pressure or material compatibility. In such situations, a plate heat exchanger ensures system separation between the temperature control instrument circuit and the application circuit, thus enabling the use of JULABO devices.

The heat exchangers are compact, professionally insulated and, thanks to our decades of experience, always optimally tailored to customer-specific requirements. This includes topics such as dimensioning, connections, performance characteristics or desired temperature control medium.

Application examples

- Temperature control of osmosis water in the temperature range of +4 °C to +84 °C.
- Cool-down and condensation of gases / vapors
- Cool-down of gear oil to temperatures down to -40 °C, following by maintenance of the required temperature after self-heating

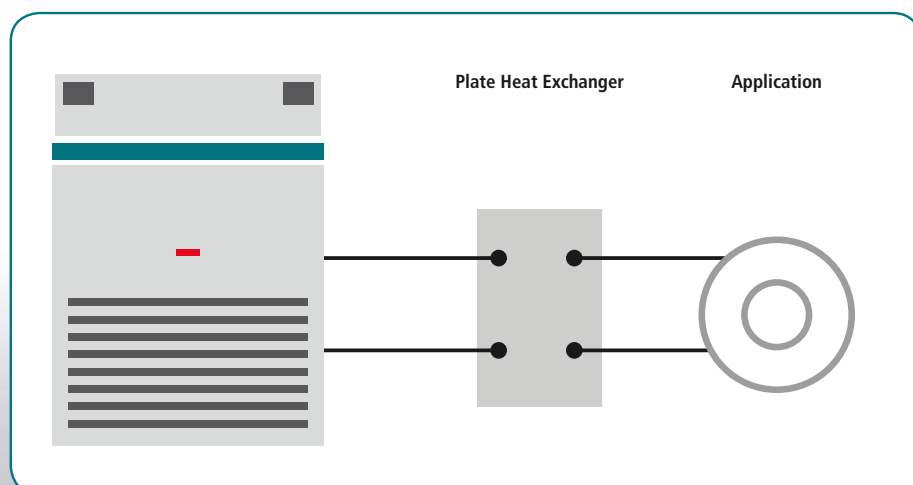

RECIRCULATING COOLERS

Environmentally-friendly and Economic

JULABO recirculating coolers can handle virtually any cooling requirements in laboratories or industrial environments. Their efficiency makes them an environmentally-friendly and economical alternative to cooling with tap water. Compact models from JULABO are ideal for placement on or underneath a lab bench. JULABO offers several powerful models with up to 20 kW of cooling capacity for applications in industrial environments.

Exclusive to JULABO instruments

JULABO recirculating coolers have no vents on the side panels. This means that you can save space by placing several instruments directly next to each other.

- Environmentally-friendly operation with low energy consumption
- Ergonomic design and easy operation
- Working temperature ranges from -25 °C to +130 °C
- Cooling capacity up to 20 kW
- Splash-proof keypad
- Large and bright LED display

- Alarm output (potential free contact) and RS232 interface on virtually all models
- Level indicator
- More powerful models with feed pressure indicator
- Circulating pumps with flow rates up to 80 l/min and pressure up to 87 psi
- Easy access filling
- Drain tap easily accessible
- No side vents, instruments can be placed right next to each other
- Air- and water-cooled models available
- High quality: All parts in contact with the bath fluid are made of stainless steel or high grade plastic (except FC-T models)



Cost savings (example calculation)

Cooling rotary evaporators is a common way to use recirculating coolers. For example, an average size 3-liter rotary evaporator requires approximately 175,000 liters of cooling water per year. This is almost as much as the yearly consumption of a four-person household! The calculation below is for cooling of two rotary evaporators:

Water is valuable and costly

The example calculation indicates cost savings of more than \$1300 per year! Therefore, a JULABO recirculating cooler will pay for itself just after two years and make a contribution to environmental protection. Increased solvent recovery provides additional saving. The health of the lab employees benefits as well from ambient air with significantly less solvent content.

Application parameters

Cooling water inlet: +15 °C
 Cooling water outlet: +17 °C
 Water flow rate: 1.6 gal per minute

Calculation of cooling capacity

$P = \Delta T * c * m/t$
 $\Delta T = 2 \text{ °C}$ (temperature difference)
 $c = 4.18 \text{ kJ/kg * K}$ (specific heat capacity of water)
 $m/t = 0.05 \text{ l/sec}$ (water flow rate)

The required cooling capacity is 560 W.

Cooling water costs

4 liters per minute = 96 gal per hour
 Operating time/year = 250 days x 8 hours
 Consumption per year = 192.000 gal

Costs for operating a recirculating cooler (F601)

Power consumption = 1.05 kW
 Operating time/year = 250 days x 8 hours
 Consumption/year = 2100 kWh

New York City (water/sewer)

Cost per HCF* = \$ 6.76 (includes water / sewer)
 Cost per year = \$ 1735.19
 Cost savings per year = \$ 1315.19

Cost per kWh = \$ 0.20*
 Cost per year = \$ 420.00*

San Diego (water/sewer)

Cost per HCF* = \$ 6.972 (includes water / sewer)
 Cost per year = \$ 1788.25
 Cost savings per year = \$ 1385.87

Cost per kWh = \$ 0.19161*
 Cost per year = \$ 402.38*

*HCF=hundred cubic feet (748.05 gal); costs vary significantly based upon location.



RECIRCULATING COOLERS

Individual and Efficient

Individual solutions for your application

JULABO is ready to help its customers by providing custom solutions for special requirements. JULABO recirculating coolers can be customized in the following ways:

Electric switch output

Some applications require an additional switch output in order to connect a solenoid valve or enable evaluation of a status signal, for example. In situations like these, JULABO can integrate the connection of your choice into the recirculating cooler. All we need to know is the signal level and the desired connector type.

Higher cooling capacity

Does your application require greater cooling capacity at a specific operating point? If so, please speak with a JULABO expert. Define the required cooling capacity and corresponding operating point. Upon request, you will receive exactly the instrument that you need.



Extraction

Quality control applications in laboratories for determination of fat content and extractable substances in food, animal feed, etc. used in the feed, animal nutrition, and dairy industries.

Extraction without consumption of cooling water, consistently reproducible condensation temperatures, without influence of ambient or seasonal temperature fluctuations.

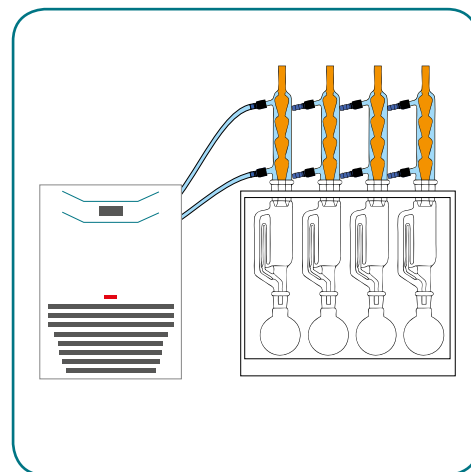

Model	FL300 F250	FL601 F500	FL601	FL1201 F1000	FL1701 FL1201	FL1701	FL2503
Number of condensers	2	4	6	8	12	18	24

Distillation

Common applications in QA laboratories for determination of alcohol, ethanol, or carbolic levels. Primarily used in the food, beverage, animal feed, cosmetics, and detergent industries as well as in clarification plants.

Distillation without use of tap water, with more effective and reproducible cooling and consistent analysis conditions.

Model	FL1201 F1000	FL2503	FL2503	FL4003
Number of distillation units	1	2	3	4

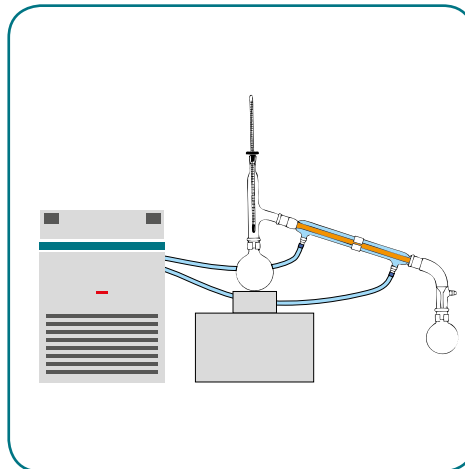

Evaporation and condensation

Commonly used in laboratories for synthetic chemistry, organic chemistry, scale-ups, or in R&D labs for pharmaceuticals, chemicals, cosmetics, and nutritional chemistry.

Evaporation and concentration without consumption of water, elevated efficiency even at cooling temperatures as low as -10 °C. Independent of external conditions.

Cooling and temperature control of 1 to 4 rotary evaporators at an evaporation temperature of +40 °C

Model	FL300 F250	FL601 F500	FL1201 FL1203 F1000	FL1201 FL1203 F1000	FL1701 FL1703	FL2503 FL4003
Flask size	0.5 -1 liters	Up to 2 liters		Up to 4 liters		Up to 20 liters
Number of rotary evaporators	1	2	3-4	1	2	1-2

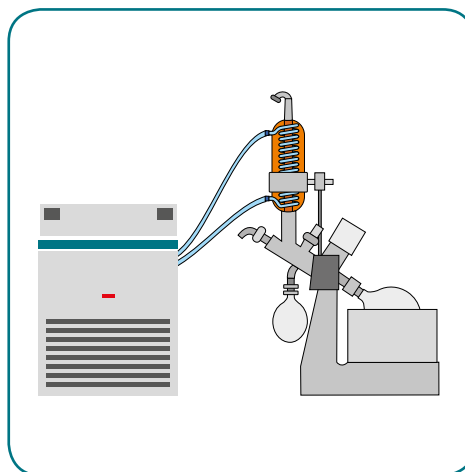

User **Benefits** and **Helpful Tips**



Adjustable pump capacity!

JULABO customers have several different options for controlling the pressure and flow rate in recirculating coolers:

1
The simplest option is a manually controlled, steplessly adjustable valve (e.g. accessory 8 970 454).

2
Models FL1203 and above have an adjustment wheel on the rear of the unit. The wheel provides for stepless pressure and flow control and diversion through the internal bypass.

3
SemiChill models include adjustable pumps.



Order at the same time!
Shut-off valve for recirculating coolers

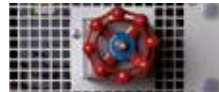

Adjustment wheel at rear



Electronically controllable pumps

Autostart function after power failure!

All JULABO recirculating coolers have an autostart function. In order to comply with industrial standards, the factory setting is "Off".

A simple key combination makes it easy for a JULABO user to activate the autostart function. Then the recirculating cooler will restart automatically after a power interruption.

USER TIP

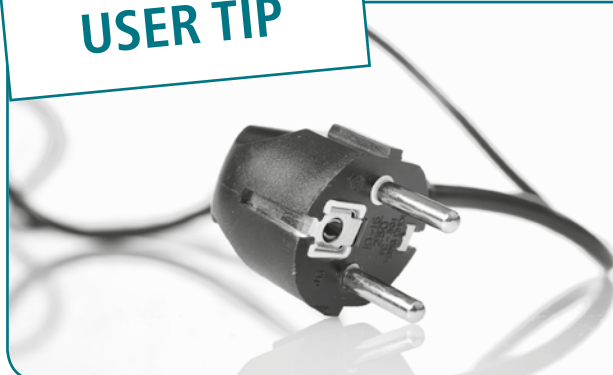

Pump protection

Other units on the market contain pumps (e.g. PD pumps) that may not run up against a closed pump connection without causing damage to the pump.

But pumps used in JULABO units are equipped with technology to ensure that they will not be damaged even if the external liquid loop is interrupted by a kink in the tube, for example.



JULABO pumps work reliably even with back pressure

The **Julabo** advantages at a glance.

JULABO temperature control solutions – high-precision and speed

JULABO products include high-quality temperature control solutions to cover the temperature range -95 °C to +400 °C.



Refrigerated Circulators

The JULABO Refrigerated Circulators are suitable for internal and external applications and can be used within the temperature range -95 °C to +200 °C.

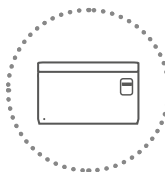

Water Baths and Shaking Water Baths

JULABO Water Baths and Shaking Water Baths can be used for a variety of applications within the temperature range +18 °C to +99.9 °C.

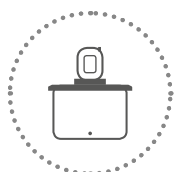

Heating Circulators

Heating Circulators are available in various designs including Heating Immersion Circulators, Open Heating Bath Circulators, or Heating Circulators and cover the temperature range +20 °C to +300 °C.



Additional Products

In addition, the JULABO product portfolio offers instruments for special requirements such as Calibration Baths, Visco Baths, Beer Forcing Test Baths, Immersion/Flow-Through Coolers, Temperature Controllers and Refrigerators for Chemicals.



Highly Dynamic Temperature Control Systems

The Highly Dynamic Temperature Control Systems from JULABO can be used for demanding temperature applications ranging from -92 °C to +400 °C. The PRESTO series offers unique high-performance specifications to meet these requirements.

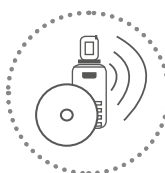

Wireless Communication & Software Solutions

JULABO facilitates the automation of applications. The temperature control instruments can be comfortably controlled and monitored via PC.



Recirculating Coolers

JULABO Recirculating Coolers are highly efficient and therefore offer an environmentally friendly and economic alternative to tap water cooling in the temperature range -25 °C to +130 °C.



Accessories

The extensive range of instrument accessories ensures JULABO products are adaptable for research and industry use.

Comprehensive service and on-site support

JULABO takes pride in offering customers expert advice for pairing the proper JULABO temperature control solution to their specific application. JULABO service and support options include installation and calibration, equipment qualification documentation and application training. These invaluable services ensure customer confidence in the operation and maintenance of any JULABO unit.

Individual requirements – individual products

JULABO's wide product range offers a solution for almost any application. However, if a specific application needs more than a standard product can offer, the JULABO specialists will work out an individual solution with you.



JULABO. Quality.

Highest quality standards to ensure a long product life.



Green technology.

Deliberately engineered with environmentally friendly materials and technologies.



Satisfied customers.

11 subsidiaries and more than 100 partners worldwide guarantee fast and qualified JULABO support.



100 % checked.

100 % testing. 100 % quality. Every JULABO product is shipped to customers after a successful final inspection.



Quick start.

Individual JULABO consultation and comprehensive manuals at your disposal.



Services 24/7.

Around the clock availability. You can find suitable accessories, data sheets, manuals, case studies and more at www.julabo.us.

Technical Specifications

Recirculating Coolers/Chillers

Model	Order No.	Working temperature range °C	Display/resolution	Temperature control	Temperature stability °C	Heating capacity kW	Cooling of refrigeration unit	Cooling capacity (kW)	
								+20	+10
AWC100	9 630 100	+20 ... +40	-	-	-	-	Air	0.55	0.3
F250	9 620 025	-10 ... +40	LED/0.1	PID1	±0.5	-	Air	0.25	0.22
F500	9 620 050	0 ... +40	LED/0.1	PID1	±0.5	-	Air	0.5	0.4
F1000	9 620 100	0 ... +40	LED/0.1	PID1	±0.5	-	Air	1	0.7
FL300	9 660 003	-20 ... +40	LED/0.1	PID1	±0.5	-	Air	0.3	0.25
FL601	9 661 006	-20 ... +40	LED/0.1	PID1	±0.5	-	Air	0.6	0.5
FL1201	9 661 012	-20 ... +40	LED/0.1	PID1	±0.5	-	Air	1.2	1
FL1203	9 663 012	-20 ... +40	LED/0.1	PID1	±0.5	-	Air	1.2	0.9
FL1701	9 661 017	-20 ... +40	LED/0.1	PID1	±0.5	-	Air	1.7	1.5
FL1703	9 663 017	-20 ... +40	LED/0.1	PID1	±0.5	-	Air	1.7	1.4
FLW1701	9 671 017	-20 ... +40	LED/0.1	PID1	±0.5	-	Water	1.7	1.5
FLW1703	9 673 017	-20 ... +40	LED/0.1	PID1	±0.5	-	Water	1.7	1.4
FL2503	9 663 025	-20 ... +40	LED/0.1	PID1	±0.5	-	Air	2.5	2.2
FL2506	9 666 025	-15 ... +40	LED/0.1	PID1	±0.5	-	Air	2.5	1.9
FL4003	9 663 040	-20 ... +40	LED/0.1	PID1	±0.5	-	Air	4	3.4
FL4006	9 666 040	-20 ... +40	LED/0.1	PID1	±0.5	-	Air	4	2.9
FLW2503	9 673 025	-20 ... +40	LED/0.1	PID1	±0.5	-	Water	2.7	2.5
FLW2506	9 676 025	-15 ... +40	LED/0.1	PID1	±0.5	-	Water	2.5	1.9
FLW4003	9 673 040	-20 ... +40	LED/0.1	PID1	±0.5	-	Water	4.3	3
FLW4006	9 676 040	-15 ... +40	LED/0.1	PID1	±0.5	-	Water	4	3
FL7006	9 666 070	-20 ... +40	LED/0.1	PID1	±0.5	-	Air	7	6.4
FL11006	9 666 110	-20 ... +40	LED/0.1	PID1	±0.5	-	Air	11	9
FL20006	9 666 200	-25 ... +40	LED/0.1	PID1	±0.5	-	Air	20	15
FLW7006	9 676 070	-20 ... +40	LED/0.1	PID1	±0.5	-	Water	7.4	-
FLW11006	9 676 110	-20 ... +40	LED/0.1	PID1	±0.5	-	Water	11.5	9
FLW20006	9 676 200	-25 ... +40	LED/0.1	PID1	±0.5	-	Water	20	15
FC600	9 600 060	-20 ... +80	LED/0.1	PID1	±0.2	1.2	Air	0.6	0.47
FC600S	9 600 063	-10 ... +80	LED/0.1	PID1	±0.2	1.2	Air	0.5	0.37
FC1600	9 600 160	-20 ... +80	LED/0.1	PID1	±0.2	1.2	Air	1.65	1.25
FC1600S	9 600 163	-15 ... +80	LED/0.1	PID1	±0.2	1.2	Air	1.55	1.15
FC1600T	9 600 166	-15 ... +80	LED/0.1	PID3	±0.2	1.2	Air	1.45	1.05
FCW600	9 601 060	-20 ... +80	LED/0.1	PID1	±0.2	1.2	Water	0.6	0.47
FCW600S	9 601 063	-10 ... +80	LED/0.1	PID1	±0.2	1.2	Water	0.5	0.37
FCW2500T	9 601 256	-25 ... +80	LED/0.1	PID3	±0.2	1.2	Water	2.5	2
SC2500a ¹	9500025XXP3H0D0M0	+5 ... +35	Depending on electronics	PID1	±0.1	*	Air	2.5	2
SC2500w ¹	9500026XXP3H0D0M0	+5 ... +35	Depending on electronics	PID1	±0.1	*	Water	2.5	2
SC5000a ^{2,3}	9500050XXP3H0D0M0	+5 ... +35	Depending on electronics	PID1	±0.1	*	Air	5.0	3.8
SC5000w ^{2,3}	9500051XXP3H0D0M0	+5 ... +35	Depending on electronics	PID1	±0.1	*	Water	5.0	3.8
SC10000w ^{2,3}	9500101XXP3H0D0M0	+5 ... +35	Depending on electronics	PID1	±0.1	*	Water	10.0	7.5

¹⁾ with option H1: current consumption = plus 5 A ²⁾ with option H5: current consumption = plus 7 A ³⁾ with option H12: current consumption = plus 11 A

Heating capacity (kW) at bath temperature (°C) Medium: JULABO Thermal Ethanol)					Type ☉ Pressure pump	Pump Pressure psi	Flow rate l/min	Pump connection / thread male	Barbed fittings dia.	Pressure Indicator psi
+5	0	-5	-10	-20						
0.18	-	-	-	-	☉	7.1	3.5	M10×1	8/10 mm	No
0.21	0.18	0.09	-	-	☉	5.1	15	M10×1	8/10 mm	No
0.3	0.25	-	-	-	☉	7.3	24	M16×1	8/12 mm	No
0.55	0.35	-	-	-	☉	14.5	23	M16×1	8/12 mm	No
0.22	0.2	-	0.15	0.1	☉	5.1	15	M16×1	8/12 mm	No
0.45	0.4	-	0.33	0.2	☉	14.5	23	M16×1	8/12 mm	No
1	0.9	-	0.6	0.3	☉	14.5	23	M16×1	8/12 mm	Yes
0.9	0.8	-	0.5	0.2	☉	7.3 ... 43.5	40	G 3/4"	3/4"	Yes
1.3	1.1	-	0.85	0.4	☉	14.5	23	M16×1	8/12 mm	Yes
1.2	1	-	0.75	0.3	☉	7.3 ... 43.5	40	G 3/4"	3/4"	Yes
1.3	1.1	-	0.85	0.4	☉	14.5	23	M16×1	8/12 mm	Yes
1.3	1	-	0.75	0.3	☉	7.3 ... 43.5	40	G 3/4"	3/4"	Yes
1.9	1.5	-	1.2	0.55	☉	7.3 ... 43.5	40	G 3/4"	3/4"	Yes
1.5	1	-	0.3	-	☉	7.3 ... 87	60	G1 1/4"	1"	Yes
2.4	2.4	-	1.5	0.65	☉	7.3 ... 43.5	40	G 3/4"	3/4"	Yes
2.4	1.9	-	0.9	0.05	☉	7.3 ... 87	60	G1 1/4"	1"	Yes
2.1	1.7	-	1	0.4	☉	7.3 ... 43.5	40	G 3/4"	3/4"	Yes
1.45	1	-	0.3	-	☉	7.3 ... 87	60	G1 1/4"	1"	Yes
2.6	2.2	-	1.3	0.45	☉	7.3 ... 43.5	40	G 3/4"	3/4"	Yes
1.35	1.7	-	0.7	-	☉	7.3 ... 87	60	G1 1/4"	1"	Yes
5.8	5.1	-	3	1.55	☉	7.3 ... 87	60	G1 1/4"	1"	Yes
8.3	7.5	-	5	3	☉	7.3 ... 87	60	G1 1/4"	1"	Yes
12.5	10	-	6	2.5	☉	11.6 ... 87	80	G1 1/4"	1"	Yes
7	7	-	3.1	1.3	☉	7.3 ... 87	60	G1 1/4"	1"	Yes
8.2	7.3	-	4.8	2.7	☉	7.3 ... 87	60	G1 1/4"	1"	Yes
13.5	12	-	7	3	☉	11.6 ... 87	80	G1 1/4"	1"	Yes
0.4	0.33	0.27	0.21	-	☉	7.3	20	M16×1	8/12 mm	No
0.3	0.24	0.15	0.1	-	☉	17.4	22	M16×1	8/12 mm	No
1	0.8	0.63	0.47	-	☉	7.3	20	M16×1	8/12 mm	Yes
0.9	0.76	0.5	0.36	-	☉	17.4	22	M16×1	8/12 mm	Yes
0.8	0.5	0.38	0.25	-	☉	50.8	28	M16×1	8/12 mm	Yes
0.4	0.33	0.27	0.21	-	☉	7.3	20	M16×1	8/12 mm	Yes
0.3	0.24	0.6	0.1	-	☉	17.4	22	M16×1	8/12 mm	Yes
1.8	2	1.4	0.8	0.25	☉	50.8	28	M16×1	8/12 mm	Yes
1.8	1.5	1.2	0.9	-	☉	-	33	NPT 3/4"	3/4"	Yes
1.8	1.5	1.2	0.9	-	☉	-	33	NPT 3/4"	3/4"	Yes
3.2	2.5	1.9	1.2	-	☉	-	33	NPT 3/4"	3/4"	Yes
3.2	2.5	1.9	1.2	-	☉	-	33	NPT 3/4"	3/4"	Yes
6.3	5.0	3.8	2.5	-	☉	-	33	NPT 3/4"	3/4"	Yes

*) with integrated heater: heating capacity H1 = 1 kW, H5 = 5 kW, H12 = 12 kW

Filling volume	Classification acc. to DIN 12876-1	IP Class acc. to IEC 60529	Power requirement	Noise level	RS232 Interface	Dimensions W × L × H	Weight net	Model
liters			V/Hz/A	dBA		inch	lbs	
0.9	I (NFL)	IP21	230/50-60/1	55	No	7.9 × 13.4 × 11.8	21.4	AWC100
1.7 ... 2.6	I (NFL)	IP20	230/50/2	59	No	9.4 × 15.7 × 20.5	59.5	F250
5 ... 7.5	I (NFL)	IP20	230/50/3	62	No	14.8 × 17.3 × 23.2	81.6	F500
7 ... 9.5	I (NFL)	IP20	230/50/3	62	No	14.8 × 19.3 × 25.2	99.2	F1000
3 ... 4.5	I (NFL)	IP21	230/50/3	55	Yes	9.8 × 19.7 × 23.6	77.2	FL300
5.5 ... 8	I (NFL)	IP21	230/50/5	55	Yes	12.6 × 19.7 × 24.4	105.8	FL601
12 ... 17	I (NFL)	IP21	230/50/7	61	Yes	19.7 × 29.9 × 25.2	172	FL1201
12 ... 17	I (NFL)	IP21	230/50/12	61	Yes	19.7 × 29.9 × 25.2	200.6	FL1203
12 ... 17	I (NFL)	IP21	230/50/10	62	Yes	19.7 × 29.9 × 25.2	172	FL1701
12 ... 17	I (NFL)	IP21	230/50/12	63	Yes	19.7 × 29.9 × 25.2	200.6	FL1703
12 ... 17	I (NFL)	IP21	230/50/10	59	Yes	19.7 × 29.9 × 25.2	180.8	FLW1701
12 ... 17	I (NFL)	IP21	230/50/12	60	Yes	19.7 × 29.9 × 25.2	194	FLW1703
24 ... 30	I (NFL)	IP21	230/50/11	64	Yes	23.6 × 29.9 × 45.3	321.9	FL2503
24 ... 30	I (NFL)	IP21	230/50/14	64	Yes	23.6 × 29.9 × 45.3	348.3	FL2506
24 ... 30	I (NFL)	IP21	3 × 400/50/8	67	Yes	23.6 × 29.9 × 45.3	326.3	FL4003
24 ... 30	I (NFL)	IP21	3 × 400/50/12	67	Yes	23.6 × 29.9 × 45.3	346.1	FL4006
24 ... 30	I (NFL)	IP21	230/50/11	61	Yes	23.6 × 29.9 × 45.3	315.3	FLW2503
24 ... 30	I (NFL)	IP21	230/50/14	61	Yes	23.6 × 29.9 × 45.3	352.7	FLW2506
24 ... 30	I (NFL)	IP21	3 × 400/50/8	65	Yes	23.6 × 29.9 × 45.3	317.5	FLW4003
24 ... 30	I (NFL)	IP21	3 × 400/50/13	65	Yes	23.6 × 29.9 × 45.3	352.7	FLW4006
39 ... 47	I (NFL)	IP21	3 × 400/50/14	74	Yes	30.7 × 33.5 × 58.3	555.6	FL7006
39 ... 47	I (NFL)	IP21	3 × 400/50/17	74	Yes	30.7 × 33.5 × 58.3	546.7	FL11006
15 ... 37	I (NFL)	IP21	3 × 400/50/18	73	Yes	37.4 × 45.3 × 63.4	826.7	FL20006
39 ... 47	I (NFL)	IP21	3 × 400/50/14	74	Yes	30.7 × 33.5 × 58.3	511.5	FLW7006
39 ... 47	I (NFL)	IP21	3 × 400/50/17	74	Yes	30.7 × 33.5 × 58.3	551.2	FLW11006
15 ... 37	I (NFL)	IP21	3 × 400/50	69	Yes	37.4 × 45.3 × 63.4	751.8	FLW20006
6 ... 8	III (FL)	IP21	230/50/8	51	Yes	13.8 × 21.3 × 19.3	105.8	FC600
6 ... 8	III (FL)	IP21	230/50/10	54	Yes	13.8 × 21.3 × 19.3	97	FC600S
8 ... 11	III (FL)	IP21	230/50/11	53	Yes	18.1 × 24 × 19.3	143.3	FC1600
8 ... 11	III (FL)	IP21	230/50/13	57	Yes	18.1 × 24 × 19.3	145.5	FC1600S
8 ... 11	III (FL)	IP21	230/50/13	58	Yes	18.1 × 24 × 19.3	147.7	FC1600T
6 ... 8	III (FL)	IP21	230/50/8	51	Yes	13.8 × 21.3 × 19.3	99.2	FCW600
6 ... 8	III (FL)	IP21	230/50/10	54	Yes	13.8 × 21.3 × 19.3	99.2	FCW600S
8 ... 11	III (FL)	IP21	230/50/12	53	Yes	18.1 × 24 × 19.3	163.1	FCW2500T
21 ... 33	III (FL)	IP21	230/50/10	65	Yes	19.3 × 24.4 × 41.3	264.6	SC2500a *1
21 ... 33	III (FL)	IP21	230/50/10	63	Yes	19.3 × 24.4 × 41.3	270.1	SC2500w *1
43 ... 60	III (FL)	IP21	3 × 400/50/11	71	Yes	23.2 × 26.4 × 44.1	337.3	SC5000a *2,3
43 ... 60	III (FL)	IP21	3 × 400/50/11	69	Yes	23.2 × 26.4 × 44.1	337.3	SC5000w *2,3
43 ... 60	III (FL)	IP21	3 × 400/50/18	69	Yes	23.2 × 26.4 × 44.1	341.7	SC10000w *2,3

Unless otherwise indicated, all data relates to the operation at nominal voltage and frequency and +20 °C ambient temperature. Cooling capacity measured according to DIN 12876-2. Information regarding used refrigerants can be found at www.julabo.com

Voltage Options

Recirculating Coolers/Chillers

Model	Rated voltage (V)	Frequency (Hz)	Power requirement type	Voltage range (V)	
Single phase units:					
				100	120
AWC100	100-230	50-60	1	[100-230]	
F250 F500	100	50-60	1	[100]	[100-120]
F250	200	50-60	1	[200]	[200-230]
F250, F500, F1000	115	60	1	[115]	[115-130]
F250, F500, F1000	230	50	1	[230]	[230-240]
	230	60	1	[230]	[230-240]
FL300 FL601	100	50-60	1	[100]	[100-120]
	115	60	1	[115]	[115-130]
	230	50	1	[230]	[230-240]
	230	60	1	[230]	[230-240]
FL1201 FL1203 FL1701 FL1703 FLW1703	115	60	1	[115]	[115-130]
	230	50	1	[230]	[230-240]
	230	60	1	[230]	[230-240]
FL2503 FLW2503 FL2506 FLW2506	230	50	1	[230]	[230-240]
	230	60	1	[230]	[230-240]
Three phase units					
				180	230
FL4003 FLW4003 FL4006 FLW4006	400	50	2	[400]	[400-430]
	230	60	2	[230]	[230-280]
FL7006 FLW7006 FL11006 FLW11006	400	50	2	[400]	[400-430]
	230	60	2	[230]	[230-280]
FLW20006	400	50	3	[400]	[400-430]
	230	60	2	[230]	[230-280]
Single phase units					
				110	130
FC600, FC600S FC1600, FC1600S FC1600T FCW600 FCW600S FCW2500T	230	50	1	[230]	[230-250]
	230	60	1	[230]	[230-250]
				190	200
SC2500a SC2500w	230	50	1	[230]	[230-260]
	208-230	60	1	[208-230]	[208-260]
Three phase units					
				180	230
SC5000a, SC5000w SC10000w	400	50	2	[400]	[400-430]
	208-230	60	3	[208-230]	[208-260]

Power requirement

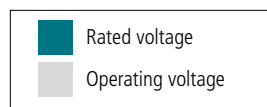
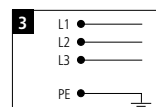
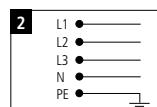
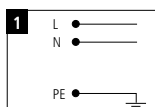



NORTH AMERICA

JULABO USA Inc.

884 Marcon Boulevard
Allentown, PA 18109
United States of America

Tel. +1 610 231 0250
Fax +1 610 231 0260
Tollfree +1 800 458 5226

info@julabo.us
www.julabo.us

GERMANY Headquarters

JULABO GmbH
www.julabo.com

ITALY

JULABO Italia Srl.
www.julabo.com

UK

JULABO UK, Ltd.
www.julabo.com

FRANCE

JULABO France SAS
www.julabo.com

NETHERLANDS

JULABO Nederland B.V.
www.julabo.com

JAPAN

JULABO Japan Co., Ltd.
www.julabo-japan.co.jp

KOREA

JULABO Korea Co., Ltd.
www.julabo-korea.co.kr

CHINA

JULABO Technology (Beijing) Co., Ltd.
www.julabo.com.cn

LATIN AMERICA

JULABO Latin America
www.julabo-latinamerica.com

SINGAPORE

JULABO Singapore Pte., Ltd.
www.julabo.com

INDIA

JULABO India
www.julabo.com

**Plus more than
100 partner distributors
worldwide**